

1. 1

2. 4

3. 7

4. 22

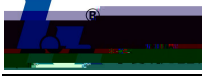

1.



危險



警告



注意

“ ”

•

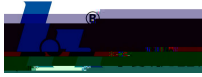

-
- -
 -
 -
 -
 -

“ ”

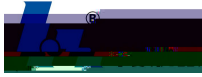

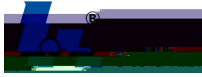

2.

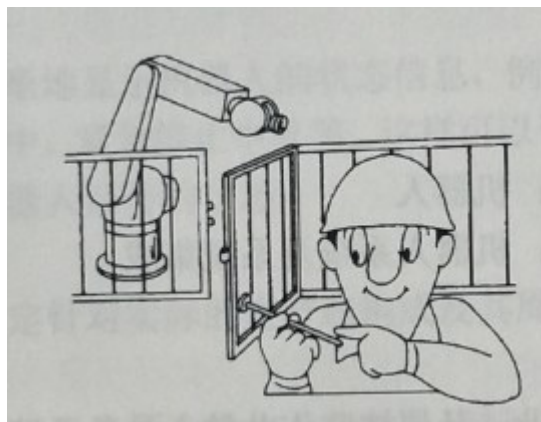
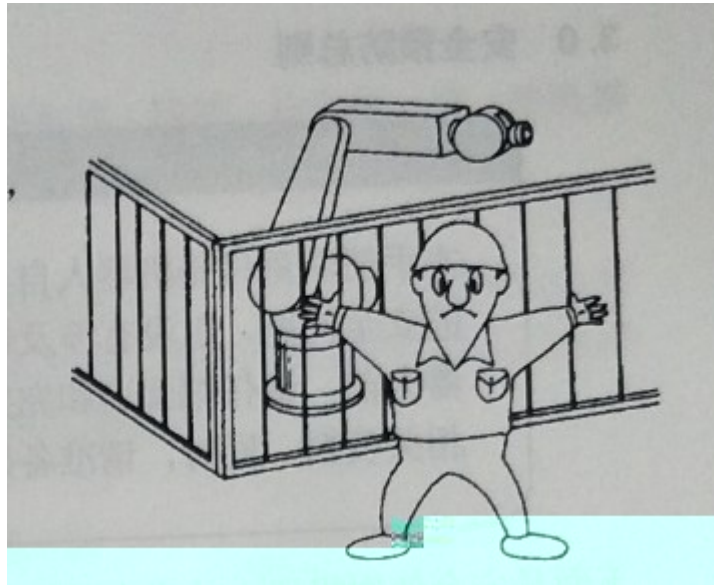

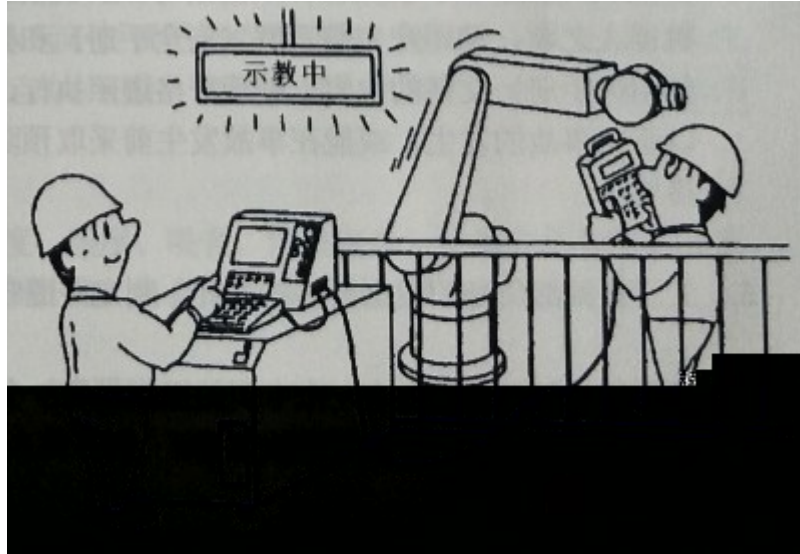
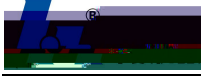







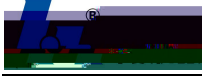

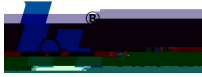

3.

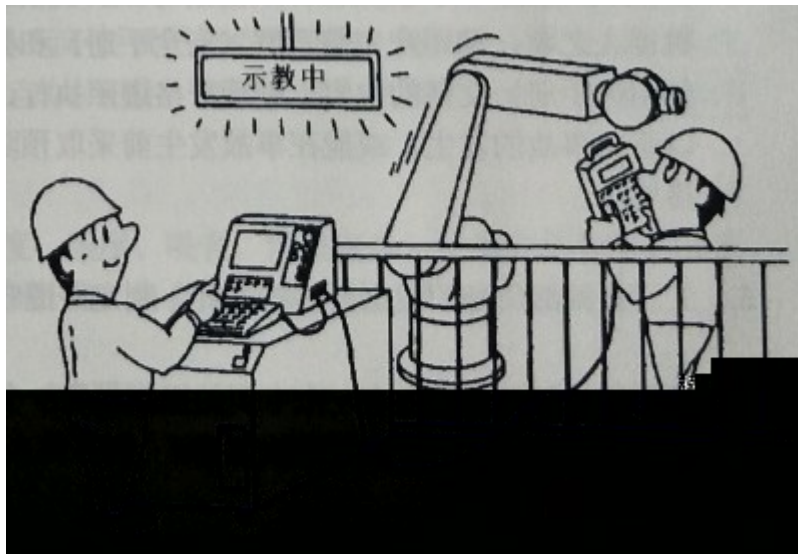

" "



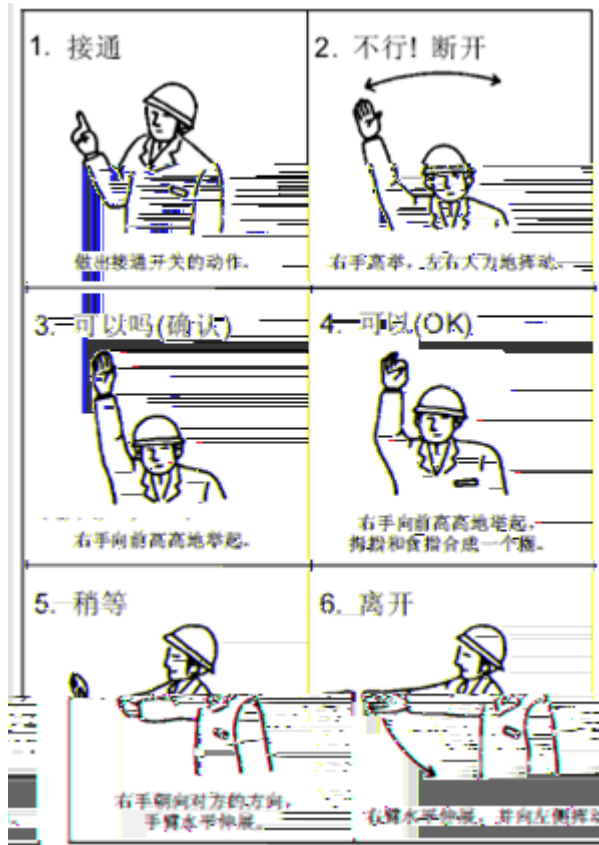

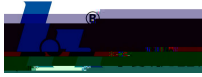

HSR-JR680

"

"



警告



警告



注意



注意

“ ” “ ” “ ” “ ” “ ” “ ” “ ”

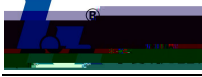

危險



注意



注意



注意



注意



注意

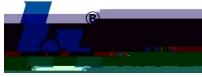



15%









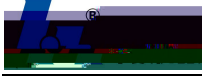











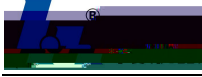

危險



危險



注意

“ ”



注意



注意



注意

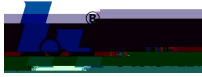

”

”



”



”



”



“ ”

“ ”

“ ”



”

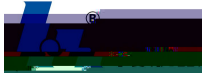

危險

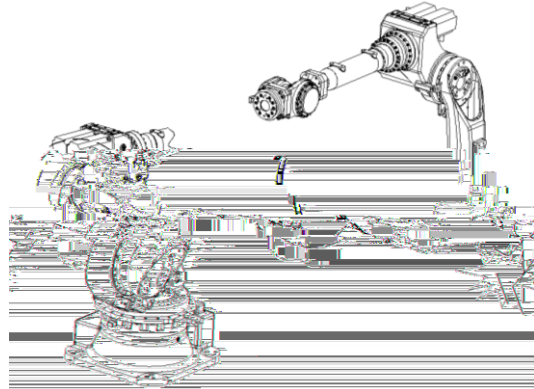

警告



警告



注意



注意

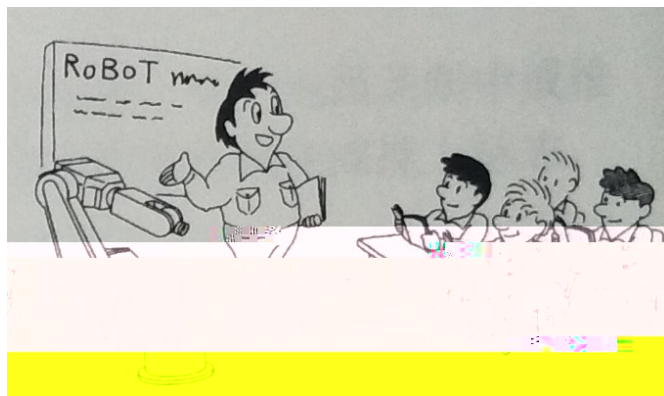
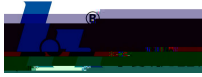

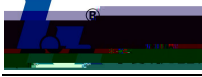

警告

“ ”



-
-
-



“ 3.3

”



-
-
-
-
-

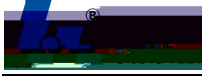

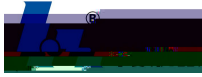

4.

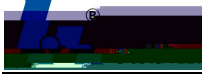

Eami l huashu@hzncc.com

<http://www.hsrobotics.cn>

